

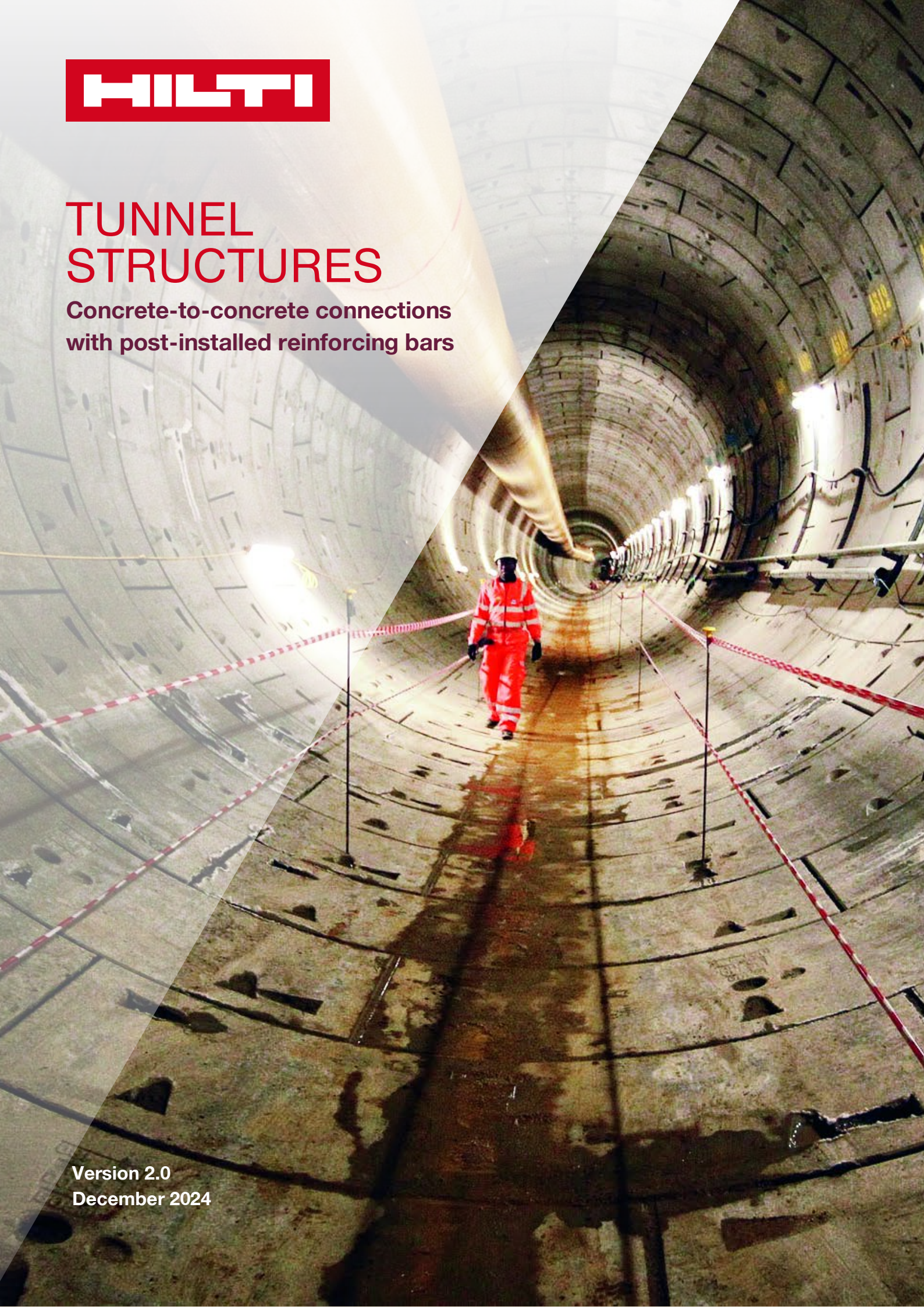

# TUNNEL STRUCTURES

Concrete-to-concrete connections  
with post-installed reinforcing bars



Version 2.0  
December 2024



Authors (Version 1.0) : Dr. Jörg Appl, Dr. Philipp Grosser and MSc. Riccardo Figoli

Authors (Version 2.0) : MSc. Kumaraguru S. and Dr. Giovacchino Genesisio

## TABLE OF CONTENT

<b>1. Introduction</b>	<b>2</b>
1.1 Application range	2
<b>2. General</b>	<b>3</b>
<b>3. Post-installed reinforcing bars in tunnels – Definition</b>	<b>3</b>
<b>4. Static design of post-installed rebar connections</b>	<b>4</b>
<b>5. Fatigue design of structural post-installed rebar connections in tunnels</b>	<b>7</b>
<b>6. Seismic design of structural post-installed rebar connections in tunnels</b>	<b>8</b>
<b>7. Requirement for extended service life</b>	<b>8</b>
<b>8. Fire</b>	<b>9</b>
<b>9. Corrosion</b>	<b>12</b>
<b>10. Hilti Product basket for Post-Installed rebar connections in tunnel construction</b>	<b>13</b>
<b>11. On site testing to support installation quality or design assumptions</b>	<b>14</b>
<b>12. Summary</b>	<b>14</b>
<b>13. References</b>	<b>14</b>

## 1. INTRODUCTION

Concrete work in underground structures is often difficult due to space restrictions and/or cross-section geometry. For example, in many tunnels suspended ceilings are installed to create separate chambers for longitudinal ventilation. It is nearly impossible to create this in one construction step with the inner lining. In the end, any concrete element that has to be connected to the lining, resulting in a monolithic connection such as walkways, suspended ceilings, vertical track dividers and corbels, must be done in a subsequent process and may result in a post-installed rebar connection. **Figure 1** provides a schematic overview of possible concrete to concrete connections in tunnels by connecting cast-in-place concrete, prefabricated concrete units or Ultra High Performance Fiber Reinforced Concrete (UHPFRC) structures with the concrete lining or within the components themselves.

**Figure 1**  
Example of common concrete to concrete connections using post-installed rebars in tunnels; wall to slab connection, slab extension, wall extension, wall extension and slab to wall connections.

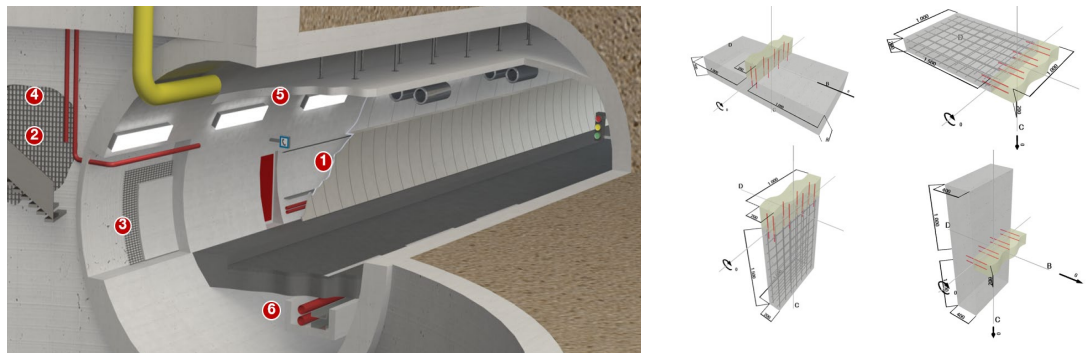

### 1.1 Application range

Post-installed reinforcing bars are typically used to create a monolithic connection between new concrete elements and the existing tunnel lining. Post-installed reinforcing bars are used in both retrofitting of tunnels and in new construction and are suitable for a wide range of applications in tunnel construction.

Examples of common applications of post-installed reinforcing bars in tunnel construction are (**Fig. 1**):

1. Opening of tunnel lining and partly closing due to installation of edge reinforcement
2. Reinforcement of concrete whaler/ diaphragm wall
3. Securing and positioning of reinforcement steel meshes
4. Replacement of misplaced cast-in rebar couplers
5. Moment resisting connection of corbel and tunnel lining for intermediate slab
6. Concrete-to-concrete connection of concrete foundation and floor members like escape platforms with tunnel lining (shear dowel applications)

Above-mentioned applications usually require the placement of a large number of bars with often close spacing. To help avoid drilling through or damaging existing reinforcing bars in the tunnel lining, reinforcing detection equipment, such as the Hilti PS 300 or Hilti PS 1000 X scanning systems, can be used.

To realize concrete-to-concrete connections in tunnels with post-installed rebar, chemical injection adhesives are preferred over the traditional bagged cement grout because of their ease of use and quality of application by providing a complete installation and cleaning system to minimize installation errors. There are numerous systems readily available in the market with different or similar product and performance characteristics covered in European Technical Assessments (ETAs). However, if not used to deal with post-installed rebar systems, one may find it difficult to understand what kind of technical

boundary conditions are considered in case of these different ETAs and what kind of product should be used for the design of such post-installed rebar connections.

It is the intention of this article to provide an overview of the use of post-installed rebar in concrete-to-concrete connections in tunnels. It should be noted that this paper does not distinguish between the different tunnel types (rail tunnel, road tunnel, utility tunnel, etc.) in detail but focuses on the technical requirements of post-installed rebar connections in general for tunnels.

## 2. GENERAL

The post-installed rebar systems for concrete-to-concrete connections in tunnels are in general selected based on structural considerations and are typically designed and detailed by a structural engineer. A detailed technical design is needed because post-installed rebar failures can lead to safety hazards and significant economic loss.

The design establishes whether the requirement of the ultimate limit state (ULS) and serviceability limit state (SLS) are met. At the ultimate limit state, it must be verified that the design values of actions do not exceed the design value of the fastening resistance. The serviceability limit state includes requirements for limiting deformation or requirements on durability as corrosion, chemical attack, temperature and other factors that may occur in tunnels. The following aspects need to be considered in the analysis of the ultimate limit state and serviceability limit state for post-installed rebar connections:

1. Type of action (static [short-term vs. long-term], fatigue, seismic, shock and fire)
2. Corrosion
3. Design life
4. Applicable design code or guideline

Additional economical or quality aspects may be considered already in the design or the specification by, for example, specifying proof loading or test loads.

## 3. POST-INSTALLED REINFORCING BARS IN TUNNELS – DEFINITION

A post-installed rebar connection consists of a reinforcing bar (rebar) installed with chemical adhesives in holes drilled into the existing concrete. The reinforcing bars connect the new and existing concrete by casting the new elements against the existing structure after the chemical adhesive is hardened (**Fig. 2**). It can be used equivalently to a straight bar cast in concrete if the adhesive is qualified accordingly. Some examples of post-installed rebar applications in tunnels are shown in **Fig. 3** such as a) connection of a corbel to the tunnel lining, b) connection of concrete floor members.

A post-installed rebar application can be characterized as follows:

(a) Post-installed reinforcing bars are straight or can be equipped with hooks or heads on the cast-in end and are necessarily straight on the post-installed end (**Fig. 2**).

(b) Post-installed reinforcing bars, in contrast to adhesive anchors, are often installed with small concrete cover ( $2\phi < c < 3\phi$ , where  $\phi$  is the reinforcement bar diameter and  $c$  is the concrete cover). This geometrical boundary condition can be given by the individual geometry of the pre-cast concrete segments of the tunnel lining in case of a TBM driven tunnel. In such cases, the strength under tension loading of the post-installed rebar connection is typically limited by the splitting strength of the concrete (as characterized by splitting cracks forming along the length of the bar).

(c) Post-installed reinforcing bars are typically not designed to resist direct shear loading, compared with rebars designed as bonded anchors or concrete overlay connections (shear dowels). In case of post-

installed rebar, shear is typically transferred by a roughened surface between existing and new concrete (**Fig. 2**).

(d) Post-installed reinforcing bars are in general embedded as required to “anchor” their design stress  $\sigma_{sd}$  using the required anchorage length and splice length provisions of Eurocode 2: “Design of concrete structures - Part 1-1: General rules and rules for buildings” [1]. In order to achieve ductility of the structure, the design stress is often close to the design yield strength.

(e) Also, the basic provisions for the anchorage length regulated in the EOTA Technical Report (TR) 069 with improved bond-splitting behavior [2] as compared to EN 1992-1-1 [1] can be applied. EOTA TR 069 [2] considers possible different modes of failure such as steel yielding, concrete cone failure, resistance to bond and splitting failures. EOTA TR 069 [2] is a combination of reinforced concrete design and anchor design in which several boundary conditions must be considered when using this design approach. For more details concerning the application and the design concept of EOTA TR 069 see [3].

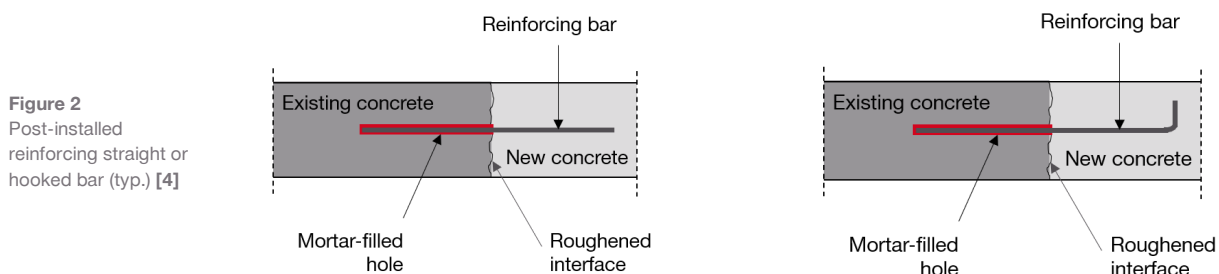

**Figure 2**  
Post-installed reinforcing straight or hooked bar (typ.) [4]

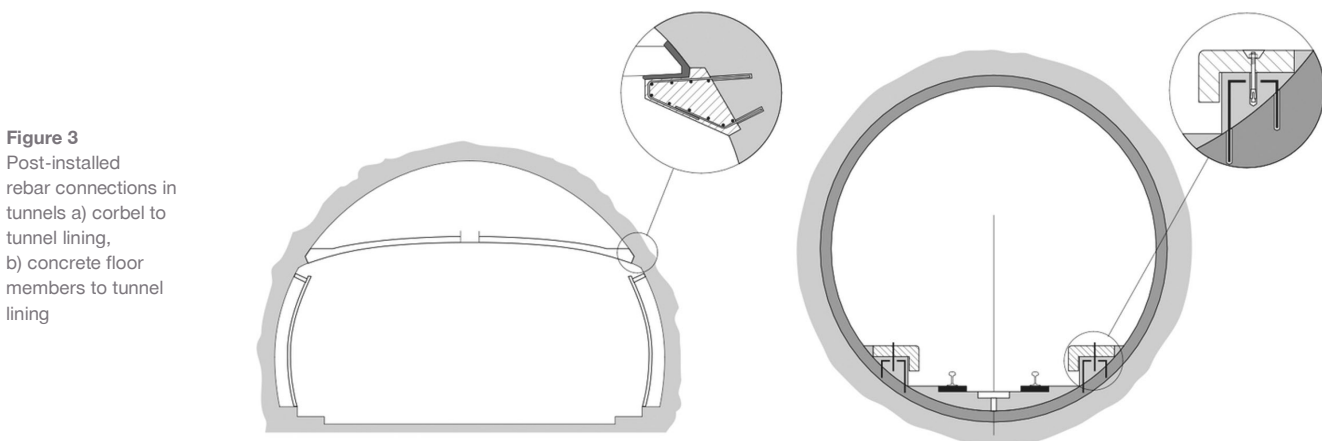

**Figure 3**  
Post-installed rebar connections in tunnels a) corbel to tunnel lining, b) concrete floor members to tunnel lining

## 4. STATIC DESIGN OF POST-INSTALLED REBAR CONNECTIONS

Although the load-carrying behavior of cast-in rebar in concrete is not identical with a post-installed rebar, the basic load transfer of an acting tension force into the concrete is similar. Both cast-in and post-installed rebar generate a rotationally symmetric stress pattern around the bar. Equilibrium is provided by the hoop stress (tangential) in the concrete. Same failure modes of cast-in and post-installed rebar can be observed. The rebars can fail by steel rupture, pullout/bond failure and splitting failure. The only difference is that for post-installed reinforcing bars, the tension loads are transferred by mechanical interlock from the reinforcing bar’s ribs to the mortar and via bond (combination of adhesion and micro

keying) from the mortar into the concrete member whereas for cast-in reinforcing bars, the tension loads are directly transferred from the rebar to the base material (**Fig. 4**).

**Figure 4**  
Schematic load-carrying mechanism of deformed reinforcing bars

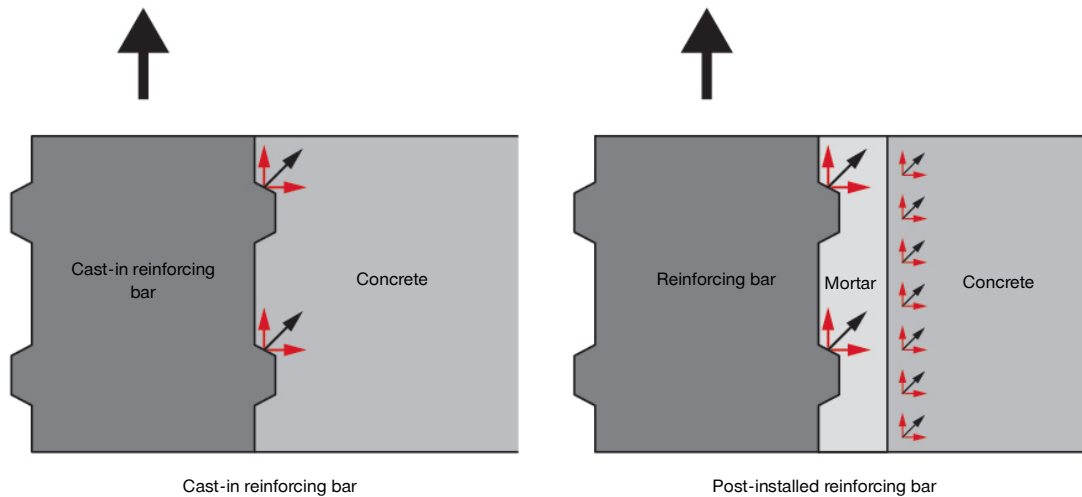

Since post-installed rebar system is similar and comparable to cast-in rebars (CIR) when straight rebars are used, they are proven in terms of assessment criteria and validated by extensive experimental test results according to EAD 330087 [7]. It is pertinent to note that EAD 330087 [7] has superseded earlier assessment criteria document EOTA TR 023 [6]. As a result, a post-installed reinforcing bar system assessed by EAD 330087 [7] results in at least comparable bond strength and comparable displacement behavior as cast-in-place reinforcing bars taking into account the influencing factors stated in the EAD 330087 [7]. Due to this core philosophy, the design of only such assessed and proven post-installed reinforcing bar connections can be done according to the provisions for cast-in-place reinforcing bars according to EN 1992-1-1 [1]. The application range of post-installed rebar covered by EN 1992-1-1 [1] provisions is limited to:

(a) **Overlap joints** of rebar connections (lap splices) for member extensions (slabs, beams, columns, walls) and overlap joints at a foundation of a column or wall by means of a non-contact splice. In this case the tension loads are transferred between adjacent bars via compression struts. The tension forces generated by the hoop stresses are taken up by the stirrups or transverse reinforcement, respectively, in the splice area.

(b) **Simply supported** beams and anchoring of reinforcement to cover the line of acting tensile forces

**Figure 5**  
Design bond strength as a function of the related concrete cover-schematic

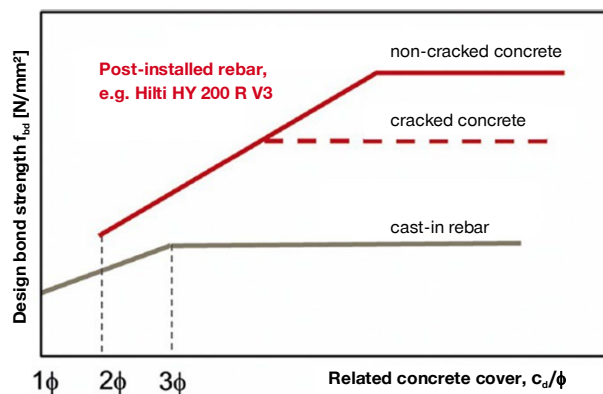

For more details on design of post-installed rebar applications using state-of-the-art methods, refer Hilti's Concrete to concrete connections Handbook



To overcome limitations of applications covered by EN 1992-1-1 [1], an EOTA Technical Report (EOTA TR 069 [2]) was developed and published in 2019 that enables design of **moment-resisting post-installed rebar connections** without the execution as a lap splice. EOTA TR 069 [2] is utilizing the bond splitting behavior of post-installed rebar systems taking into account the concrete cover in the design equations. According to **Figure 5** the value of the minimum concrete cover is greater than  $2\phi$  (where  $\phi$  is the diameter of the reinforcing bar). Post-installed rebar systems (i.e., Hilti HIT-HY 200-R V3 and HIT-RE 500 V4) exhibit significantly higher bond-splitting behavior than cast-in-place bars of equivalent bar diameter and anchorage length. This behavior can be qualified and assessed according to EAD 332402 "Post-installed reinforcing bar (rebar) connections with improved bond splitting behavior under static loading" [8]. It should be noted that the testing is extensive when compared to post-installed rebar connections that are limited to the design according to EN 1992-1-1 [1] where only the comparability of the post-installed rebar with a cast-in rebar is verified. However, both EADs (EAD 330087 [7], EAD 332402 & its variants [8], [9], [10]) provide safeguards to restrict post-installed reinforcing bar systems that exhibit very low stiffness or brittleness compared to a cast in bar.

It is also important to mention that EAD 332347 [18] provides assessment methods for essential characteristics of shear connectors which are used for design of the shear-friction connections (overlays) under static, quasi-static and fatigue cyclic loading according to EOTA TR 066 [5].

The allowable concrete-to-concrete connections taking into account connection type, allowable forces, design method, required EADs and covered load cases as shown in **Figure 6**.

**Figure 6**  
Concrete-to-concrete connections considering connection type, allowable forces, design method, required EAD and covered load cases

Connection type	Splice	End-Anchorage	End-Anchorage	End-Anchorage			Shear-friction application (Overlay)	
Shear forces and Moments	Yes	Shear forces only	Predominant compression or Strut & Tie models	Yes			Shear forces only	
Examples	All members connected via a splice (member extensions)	Simply supported beams or slabs	Wall/column to foundation	Column/Wall to Slab	Slab to Wall	Beam to Column/Wall	Concrete overlays over slabs/walls	
Design method	EN 1992-1-1 / EN 1998-1			EOTA TR 069			EN 1992-1-1 / EOTA TR 066	
Required EAD	EAD 330087			EAD 332402			EAD 330087 / EAD 332347	
Load cases	Static and sustained loading, fire, seismic			Static and sustained loading, seismic, fire (Hilti method)			Static and sustained loading, seismic, fatigue	
Working life	50 years, 100 years, 120 years			50 years, 100 years, 120 years			50 years, 100 years, 120 years	

## 5. FATIGUE DESIGN OF STRUCTURAL POST- INSTALLED REBAR CONNECTIONS IN TUNNELS

When a high-speed train is entering or passing through a tunnel, a complicated system of pressure waves develops and propagates through the tunnel and in addition the concrete foundation may be exposed to repeated loads. The resulting loads during train-tunnel passage may play an important role in the structural design of concrete-to-concrete connections. Material fatigue is relevant not only for high-speed train tunnels but also in road tunnels designed for an additional operational loading due to the wind pressure and suction caused by the moving vehicles, especially when entering the tunnel.

The authors see an increasing demand on fatigue-approved solutions in tunnels, especially in rail tunnels with high to very high load cycles over the service life of the connection. Unfortunately, while the research in case of anchors in concrete loaded under fatigue gained importance in the last decades, research on post-installed rebars under fatigue loading is rather limited. As a result, qualification and design provisions for post-installed rebars loaded under fatigue are not existing. Therefore, the following discussion has to be seen as a possible solution based on study and design approach recommended by Hilti [11] to tackle post-installed rebar applications under fatigue.

For verification of fatigue strength of post-installed rebar, three different modes of failure can be decisive: steel failure, bond failure and concrete splitting. A simplified and conservative method is provided in which the verification of steel failure follows the recommendation of EN 1992-2-1 [20], verification of bond and concrete splitting failure modes follows the recommendation by Hilti [11] and fib Model Code 2010 [21]. The design values were determined by in-house fatigue tests with post-installed rebars [11] and results of tests in literature about cast-in rebars were also considered. The actions to be used in design may be obtained from national regulations or in absence of them in the relevant parts of EN 1992-1-1 [1].

Fatigue is verified if the following equations are fulfilled:

### Steel failure:

$$\Delta N_{Ed} < \Delta N_{Rd,E,n}$$

where  $\Delta N_{Ed}$  = design fatigue action

$\Delta N_{Rd,E,n}$  = design fatigue resistance of the post-installed rebar for pulsating or alternating load taking into account the required number of load cycles

In cases where actions consist of a combination of a non-negligible lower cyclic load and a fatigue relevant part, it is necessary to determine the influence of the lower cyclic load on the fatigue resistance. This is achieved by using the Goodman diagram which is in general available for rebars. In absence of such a diagram,  $\Delta N_{Ed}$  shall be replaced by  $\Delta N_{Ed,simple}$  as follows:

### Concrete splitting or bond failure:

$$\Delta N_{Ed,simple} < k_{fat,red} \cdot R_d$$

where  $\Delta N_{Ed,simple}$  = simplified fatigue design action

$k_{fat,red}$  = Reduction factor for fatigue in case of bond and concrete-splitting failure taking into account the number of load cycles

$R_d$  = design static resistance



For more details on how to design post-installed rebar applications under fatigue loading, contact Hilti



For a simplified design in case of bond and concrete splitting failure, all loads are assumed to be fatigue relevant ( $\Delta N_{Ed, simple} = N_{Ed} + \Delta N_{Ed}$ ). It is obvious that in case of low percentage of the fatigue load compared to the static value, this approach may yield to relatively conservative results. With this approach a “static” design calculation of PIR may be performed applying the reduction factor for fatigue in case of bond and concrete failure taking into account the number of load cycles. The reduction factor  $k_{fat, red}$  ranges from lowest value of 0.5 (for compressive-stressed concrete subjected to purely pulsating loads) to higher values  $<1.0$  based on maximum stress variation during fatigue loads [11].

## 6. SEISMIC DESIGN OF STRUCTURAL POST-INSTALLED REBAR CONNECTIONS IN TUNNELS

Historically, underground utilities have experienced a low rate of damage during earthquakes than surface structures for a given intensity of ground shaking because the imposed ground strains are lower at higher depths. However, tunnels may suffer from damage due to earthquake loading by showing lining cracks, shear failure of lining, tunnel collapses caused by slope failure, portal cracking, leaking and deformation of sidewall/invert damage [14], [15], [16], [17]. It was found that for peak ground accelerations (PGAs) equal to or less than about 0.2g, ground shaking caused minor damage. For PGAs in the range of about 0.2–0.5g, some instances of slight to heavy damages were observed, whereas for PGAs larger than 0.5g there were many instances of slight to heavy damages. This may lead to the upfront need, based on the project specification, for concrete-to-concrete connections in underground structures may also be designed considering seismic conditions. Deformation must be assessed and special requirements for reinforcement detailing must also be followed.

With EAD 330087 [7] a qualification process for post-installed rebar is existing that allows a design according to EN 1998-1 “Design of structures for earthquake resistance” [19]. The assessment of post-installed reinforcing bars under cyclic (seismic) loading is conducted following the same logic adopted in the case of static loading. The performance of the system in the case of pullout (bond) and splitting failure is compared and related to the performance of cast-in bars by means of comparing and assessing the bond strength degradation of a post-installed bar system with the number of cycles.

In conclusion, the seismic design bond strength of a post-installed reinforcing bar system  $f_{bd, seis}$  and its associated bond efficiency factors based on installation conditions, that can be used in combination with the requirements of EN 1998-1 [19] is provided in the related ETA. Also, the design of end-anchorage with post-installed rebars in moment resisting connections with seismic load actions is provided by the provisions of EOTA TR 069 [2] through modifications of its design resistance equations for steel yielding, concrete cone breakout and bond-splitting failure modes.

## 7. REQUIREMENT FOR EXTENDED SERVICE LIFE

Nowadays there are more and more requests from owners or operators of tunnels for an extended service life from 50 years to 80, 100, 120 or even 200 years. The authors believe that this is a rapidly growing international demand also on post-installed rebar applications. However, it should be noted that the design life should not be confused with the service life. The service life relates to the period that the tunnel is expected to be in operation. In contrast, the design life represents the period on which the statistical derivation of transient loads is based on. The requirement for a service life and/or design life of 100 years is based on the goal of minimizing maintenance requirements and to help that the investment is spent in a rational way.

The variant of the EAD 332402-v01 [9] and 330087 [7] provide the answer to an extended working life for post-installed reinforcing bar connections of 100 years. These EADs are also the basis for Hilti to

provide engineering assessment for a working life of 120 years. The biggest difference in the assessment for an extended working life (100/120 years) in comparison to a working life of 50 years is that the long-term test is modified from a 50-years bond-strength estimation to a 100-years projection (120-years projection is an engineering assessment from technical experts outside of the EAD). The 120-year bond efficiency factors and design values of bond strength follow the same rationale used for the extension for 100 years. It includes sustained load tests with a set test duration and stringent assessment criterion for evaluating freeze-thaw test results, which fulfills the linearly scaled up requirements for a working life of 120 years.

However, it is important to note that the design life assessment in [9] is limited to the bond between mortar and concrete (bond strength) by providing bond strength values for 50 years and 100/120 years. The durability of the steel element (rebar) and the surrounding concrete is not considered within the scope of the European Assessment Document. Consequently, the EAD assumes that the material specific parameters of the concrete and the steel are not negatively influenced by the design life. Important is the definition of the correct exposure class in the tunnel projects, maximum water cement ratio, minimum cement content and consequently the required nominal concrete cover of the reinforcing bars for an extended working life.

In conclusion, the 100/120-year design bond strengths  $f_{bd,PIR,100y} / f_{bd,PIR,120y}$  of a post-installed reinforcing bar is provided in the related ETA/expert report for different load actions. The design process is the same as the design for 50 years by replacing the bond strength of 50 years  $f_{bd,PIR,50y}$  with the 100/120-year design bond strength  $f_{bd,PIR,100y} / f_{bd,PIR,120y}$ . Additional bond efficiency factors  $k_b$  (reduction factor) may be applied to the design bond strength taking into account the drilling systems and borehole conditions. Similarly, the assessed uncracked bond strength and its influencing bond-splitting resistance factors for 100/120 years working life is provided in the related ETA/expert report for design of pos-installed rebars based on EOTA TR 069 [2].

## 8. FIRE

Tunnel fires may cause structural damage due to elevated temperature in concrete, explosive spalling and violent detachment of fragments of concrete, loss of structural strength in concrete and reinforcement steel. In addition to the economic consequences, it might lead to tragic loss of human life during the event of tunnel fire. The EU directives state that all major tunnels need to be upgraded to the latest safety requirements. Therefore, higher demands are placed upon fire protection systems and also on the fire design of post-installed rebars in tunnels.

Tunnels may have post-installed reinforcing bar (PIR) connections as part of a fire-rated building-type structural assembly such as cross-passages, service ducts, and escape platforms. It is important that the fire resistance of the connection is evaluated using test data for the time-dependent reduction in bond strength associated with typical geometries and time-temperature loading protocols. These building-type structural elements in tunnels are usually assessed based on ISO 834 type fire curve (**Fig. 7a**), designed and constructed to provide a specific period of fire resistance (R), typically rated for 30, 60, 90, 120, 180 or 240 minutes. ISO 834 curve is a celluloid type of fire curve utilized in the case of fires in buildings and design using which is only applicable based on the specifications of the owners/building authorities.

However, for design of PIR in tunnels specific to major tunnel applications (main tunnel shafts, lining, diaphragm walls, etc.), it involves a different assessment of fire resistance determined by following fire curves (**Fig. 7b**) like RABT for road tunnels (RABT-ZTV-ING (Car)) and ZTV/EBA for rail tunnels (RABT-ZTV-ING (Train)). Car tunnels and train tunnels have extraordinary volume of combustible materials to burn in an event of fire. Hence, these fire curves are modified hydrocarbon(HC) based which is applicable in the case of hydrocarbon liquid or gas which is combustible in real life situations in a tunnel.

**Figure 7**

Fire curves considered in assessment for rebar applications in:  
 a) Building-type connections and  
 b) Tunnels applications

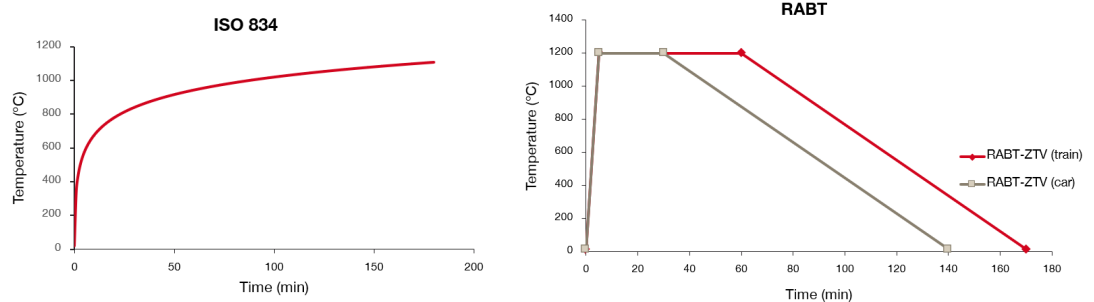

In general, the capacity of post-installed reinforcing bars is reduced when exposed to fire. The bond-strength degradation is highly product dependent. Main parameter is the composition of the used adhesive material (inorganic or organic such as vinyl ester or epoxy). Consequently, if post-installed reinforcing bars are part of a fire-rated assembly it is important to know the time-temperature dependent reduction in bond strength to properly design the connection. Based on the specific fire curve analysis/simulations and requirements of the tunnel project (like RABT, RWS, etc.), the temperature along the position of post-installed rebar can be estimated. This information can then be used to design the fire-safe embedment depths using the temperature degradation data of qualified mortars.

Contact Hilti for support on assessment of fire curves and fire design of specific tunnel applications

**For fire design of building-type structural connections in tunnel applications**, the determination of the temperature in the mortar layer is easier in case of constant distance along the length of the post-installed rebar to the flamed surface (**Fig. 8a**), which is typically the case of lap splice connections. A constant temperature distribution can be assumed that depends on the exposure time and concrete cover. In case of varying distance as in end anchorages, the determination of the temperature along the length of the post-installed rebar is only possible with the help of numerical analyses (**Fig. 8b**). The bond strength is not affected along the entire anchorage length. The load is transferred in regions with lower temperature where no decrease of bond strength takes place.

**Figure 8**

Simplified temperature distribution in the mortar layer depending on the location of the rebar relative to the flamed concrete surface

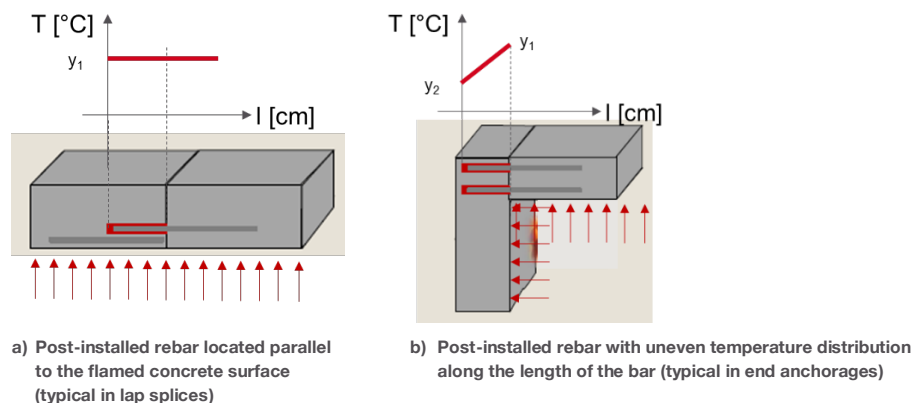

The bond strength of post-installed rebar subjected to fire is assessed based on tests according to EAD 330087 [7], which provides an equation in the ETA to calculate the temperature-dependent design value of bond resistance under fire  $f_{bd,fi}$ . When the temperature along the post-installed rebar is known, splice connections and anchorages in simply supported connections can be designed for fire resistance following the provisions of EN 1992-1-2 [22] and EN 1992-1-1 [1].

For more information on fire design of rigid end-anchorages, refer to the article «Hilti method for fire safe rigid joints»

While EOTA TR 069 [2] allows for the design of post-installed, moment-resisting end anchorages under static loading and seismic loading conditions, it does not include design provisions for fire exposure. This limitation of the design method is overcome by the new Hilti method for fire design of rigid joints. It is a smart design approach that utilizes the design strength verification equations for failure modes from EOTA TR 069 [2] (steel yielding, concrete breakout and bond-splitting) with few meticulous modifications. A key parameter in this method is the reduced bond strength in terms of the reduction factor expressed as  $k_{fi,p}(\theta)$ , of the mortar under fire taken from the relevant ETA published as per EOTA EAD 330499 [23] which is used for bonded anchors.

**The requirements for fire design of main tunnel applications can be different** as discussed earlier depending on the application, tunnel specific input fire curve, and type of tunnel. To minimize the damage in case of a fire event, the temperature on the concrete surface and the temperature in the reinforcement should be limited. Note, both the concrete and steel temperature depend on several parameters (e.g. exposure time, concrete cover, protection of concrete member). Based on the experience of the authors and as a simplification, the following temperature limitations should be used: concrete surface (200°C to 380°C) and reinforcement (250°C to 300°C). In case of higher temperatures on the concrete surface, fibers of polypropylene or steel should be incorporated into the concrete to minimize explosive spalling of concrete. However, it is noted that at such high temperatures organic adhesive material is showing a very low bond strength  $f_{bd,fi}$  which is only 10-20% of the bond strength in cold condition  $f_{bd}$ . Especially for applications in which the rebar is parallel to the flamed concrete surface (i.e. lap splices in member extensions) the impact is more pronounced which often leads to challenges in design.

To overcome this challenge, Hilti developed an injectable inorganic calcium-aluminate-based cement for post-installed rebar connections, named Hilti HIT-FP 700-R. Compared to organic mortar systems, which show no residual capacity at 500°C, Hilti HIT-FP 700-R has been tested up to 500°C and experiences a very low reduction of its bond capacity compared to concrete for which a reduction of approximately 40% is assumed at 500°C, see **Figure 9**.

**Figure 9**  
Reduction factor under fire exposure  $k_{b,fi}(\theta)$  for Hilti HIT-FP 700-R compared to several organic mortar systems in the market and concrete (example: concrete strength class C20/25))

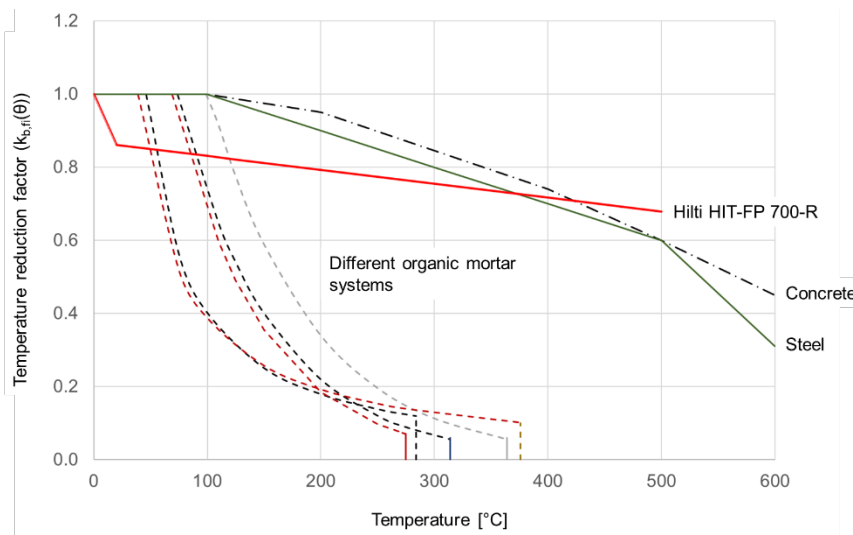



## 9. CORROSION

Concrete is an alkaline material and under normal conditions corrosion of cast-in reinforcing bars is prevented by passivation of the bar surface. However, when concrete undergoes carbonation, its decreased pH value can break the passivation film and allow corrosion. Furthermore, accelerated corrosion rates (pitting corrosion) are observed if the concrete is contaminated with chlorides. Consequently, the qualification of systems for post-installed rebar connections with mortar includes a specific test for the susceptibility of the system to long-term bar corrosion.

**Figure 10**  
Test setup to assess the long-term rebar corrosion [6]

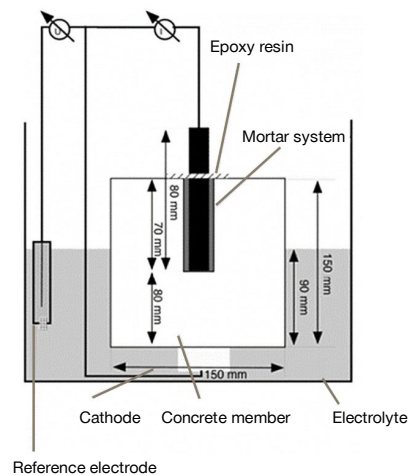

After curing of the mortar, a concrete member with an embedded post-installed rebar is immersed into a container filled with artificial tap water (sodium sulphate and sodium bicarbonate) while each rebar is connected to a cathode, see **Figure 10**. The current between the rebar and the cathode is determined by measuring the potential drop while additionally, the corrosion potential of each rebar is measured by a voltmeter. The measured current flow and the potential are plotted as a function of the time (duration of the test for at least 3 months). The measured current flow and the potential must be below a certain limiting value. In addition, a visual inspection of the rebar after the test takes place to identify signs of corrosion products. If the requirements are fulfilled, the post-installed rebars installed with a qualified mortar system exhibit similar corrosion rates to cast-in-place bars installed in the same concrete.

The Swiss Association for Protection against Corrosion (SGK) was given the assignment to evaluate the corrosion behavior of fastenings post-installed in concrete using the Hilti HIT-HY 200-R V3 and Hilti HIT-RE 500 V4 injection systems to provide further information about the corrosion behavior in addition to the “pass/fail” criteria according to the related European assessment document.

The results can be summarized as follows:

### Hilti HIT-HY 200-R V3

- The Hilti HIT-HY 200-R V3 system in combination with reinforcing bars can be considered resistant to corrosion when they are used in sound, alkaline concrete. The alkalinity of the chemical mortar helps to ensure the initial passivation of the steel.
- If rebar is installed in chloride-free concrete using Hilti HIT-HY 200-R V3, in the event of later chloride exposure, the rates of corrosion are about half of those of rebar casted-in concrete.
- In concrete containing chlorides, the corrosion behavior of Hilti HIT-HY 200-R V3 corresponds to that of cast-in rebar. Consequently, the use of unprotected steel in concrete exposed to chlorides is not recommended because corrosion can be expected after short exposure times.

### Hilti HIT-RE 500 V4

- If the Hilti HIT-RE 500 V4 system is used in corrosive surroundings, a sufficiently thick coat of adhesive significantly increases the time before corrosion starts to attack the steel.
- The Hilti HIT-RE 500 V4 system may be used in carbonated concrete containing chlorides if a coat thickness of at least 1 mm can be ensured. In this case, only the unprotected steel in the new part of the concrete joint is critical.
- In none of the cases investigated previously rusted steel (without chlorides) showed signs of an attack by corrosion, even in concrete containing chlorides.

Neither during this study an acceleration of corrosion was found at defective points in the adhesive nor there is any reference to this effect available in literature.

### Hilti HIT-FP 700

The corrosion assessment of Hilti HIT-FP 700 mortar also shows that its corrosion behaviour corresponds to that of cast-in rebar. It resists corrosion through passivation of the rebar, similar to the performance of a cementitious mortar.

## 10. HILTI PRODUCT BASKET FOR POST-INSTALLED REBAR CONNECTIONS IN TUNNEL CONSTRUCTION

Depending on the requirements - e.g., type of action (static [short-term vs. long term], seismic, fatigue and fire), corrosion, design life, design concept, installation - different products are offered by Hilti. Every product has its strengths but also its limitations. **Figure 11** shows the product portfolio Hilti is offering for anchoring post-installed rebar. The overview provides guidance on the selection of the product. Hilti is also providing PROFIS Engineering which is an efficient design software that allows for a faster and safer design of post-installed reinforcement connections.

**Figure 11**  
Overview of Hilti products used for post-installed rebar connections in tunnels



Product name	HIT-RE 500	HIT- HY 200-R	HIT-FP 700	HIT-CT 100
ETA-Rebar (EC2, static and quasi -static, 50 years design life)	Φ 8-40	Φ 8-40	Φ 8-40	Φ 8-25
ETA-Rebar (EC2, static and quasi -static, 100 years design life)	Φ 8-40 *	Φ 8-40 *	Φ 8-40	-
ETA-Rebar (TR069, static and quasi-static, 50 & 100-years design life)	Φ 8-40 *	Φ 8-32 *	-	-
Seismic assessment for EC2	Yes	Yes	Yes	No
Seismic assessment for EOTA TR 069	Yes	No	No	No
Fire assessment for EC2	Yes	Yes	Yes	Yes
Max. fire temperature [°C]	305	268	504	338
Reduction at max. fire temperature (for concrete strength class C20/25)	89%	92%	31%**	96%
Working time at 21°C	30 minutes	9 minutes	20 minutes	4 minutes
Curing time at 21°C	7 hours	60 minutes	10 days	75 minutes
Installation temperature [°C]	-5 to +40	-10 to +40	+5 to +40	-5 to +40

\*120 years based on expert assessment reports beyond the scope of the ETA

\*\*Bond-strength reduction curve of HIT-FP 700 mortar is better than that of concrete base material, hence not decisive

## 11. ON SITE TESTING TO SUPPORT INSTALLATION QUALITY OR DESIGN ASSUMPTIONS

If a post-installed rebar system carries an ETA and is installed according to the manufacturer's instruction for use (IFU) in a base material within the scope of the assessment, there is no need to verify the performance with on-site testing. However, there are only two reasons why on-site testing in tunnel construction is meaningful:

1. Missing design values: In cases where the base material is not covered in the ETA non-destructive (proof loading) or destructive tests can be performed to determine the design resistance. One example is the use of concrete with a mix composition that is outside of the scope of the qualification according to the related European Assessment Document (EAD).
2. Proof-load check: To enable customer to control and potentially validate the quality of installation of the post-installed rebars, non-destructive tests can be performed on the job site (proof tests).

In case of **non-destructive loading (proof loading)**, a tension load is applied to the rebar. The customer must select the appropriate load level depending on requirements. But in any case, loading on the system should not be so high as to result in damage (e.g. in the form of yielding or permanent slip). Proof loads should be defined by the responsible engineer and testing shall done as per applicable standards and protocols.

Figure 12  
Onsite testing services  
offered by Hilti

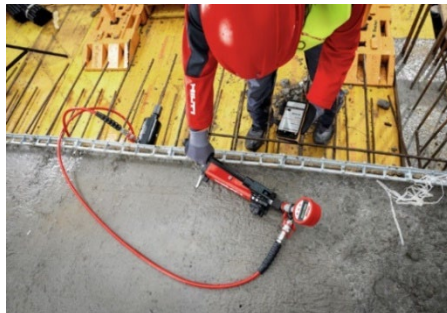

Hilti provides a complete on-site testing engineering service with appropriate testing equipment and a service for the customer for evaluation of the result/full documentation. Contact Hilti for support with engineering judgements for non-standard cases of design resistances in unknown base material conditions. For more information refer to Hilti's technical publication on OST (On-Site Testing) and the Handbook on concrete-to-concrete connections.

## 12. SUMMARY

Post-installed rebar connections are important in tunnel construction to connect new concrete elements (e.g. ceiling- or floor connections) with the existing concrete structure. Knowledge about the different technical application conditions but also selecting the right post-installed rebar system is crucial. It is the intention of this paper to provide relevant background information about concrete-to-concrete connections in tunnels realized with post-installed rebar and give guidance for the selection and design of the post-installed rebar system based on design assumptions and installation conditions at jobsites.

## 13. REFERENCES

- [1] EN 1992-1-1:2004-12: Eurocode 2 - Design of concrete structures - Part 1-1: General rules and rules for buildings, Brussels: CEN, 2004.
- [2] EOTA TR 069: Design method for anchorage of post-installed reinforcing bars (rebars) with improved bond-splitting behaviour as compared to EN 1992-1-1, Brussels: EOTA, 2021.
- [3] P. Woerle, J. Appl, G. Genesio: Anchorages for moment resisting connections in accordance with EOTA TR 069, Beton- und Stahlbetonbau, 2020

- [4] Seismic Assessment of Post-Installed Reinforcing Bars with Mortar Based on the European Organization of Technical Assessment. Available from (PDF): [https://www.researchgate.net/publication/346923346\\_Seismic\\_Assessment\\_of\\_Post-Installed\\_Reinforcing\\_Bars\\_with\\_Mortar\\_Based\\_on\\_the\\_European\\_Organization\\_of\\_Technical\\_Assessment](https://www.researchgate.net/publication/346923346_Seismic_Assessment_of_Post-Installed_Reinforcing_Bars_with_Mortar_Based_on_the_European_Organization_of_Technical_Assessment)
- [5] EOTA TR 066: Design and requirements for construction works of post-installed shear connection for two concrete layers, Brussels: EOTA, 2022.
- [6] EOTA TR 023: Assessment of post-installed rebar connections, Brussels: EOTA, 2006.
- [7] EOTA EAD 330087-01-0601 (previously referred as 331522-00-0601 and 330087-00-0601-v01): Systems for post-installed rebar connections with mortar, Brussels: EOTA, December 2020.
- [8] EOTA EAD 332402-00-0601: Post-Installed Reinforcing Bar (Rebar) Connections with Improved Bond-Splitting Behaviour Under Static Loading, Brussels: EOTA, October 2019.
- [9] EOTA EAD 332402-00-0601-v01: Post-installed reinforcing bar (Rebar) connections with improved bond-splitting behaviour under static loading: 100 years working life, Brussels: EOTA, August 2020.
- [10] EOTA EAD 332402-00-0601-v02: Post-installed reinforcing bar (Rebar) connections with improved bond-splitting behaviour under static loading and seismic action, Brussels: EOTA, November 2021 (Pending for citation in OJEU).
- [11] Dr. Jakob Kunz (AMTkj): Design of bonded-in reinforcement (post-installed rebar connections) for predominantly cyclic (fatigue) loading, Hilti Aktiengesellschaft: Liechtenstein 2013.
- [12] R. Eligehausen, R. Malle, J.F. Silva: Anchorage in Concrete Construction, *Ernst & Sohn Verlag 2006*
- [13] Kunz, J.: Chemical fastenings for fatigue loads. Joining techniques in the building construction industry, *internationals Klebetechnik-Symposium*, Munich 2003.
- [14] Y. Hashash, J. Hook, B. Schmidt, J. Yao: Seismic design and analysis of underground structures, *J Tunnelling Underground Space Technol.*, 16 (2001), pp. 247-293.
- [15] S. Okamoto: Introduction to Earthquake Engineering, *John Wiley*, New York (1973).
- [16] K. Uenishi, S. Sakurai: Characteristics of the vertical seismic waves associated with the 1995 Hyogo-Ken Nanbu (Kobe), Japan earthquake estimated from the failure of the Daikai underground station, *J Earthquake Eng. Struct. Dyn.*, 29 (6) (2000), pp. 813-821.
- [17] Z. Chen, C. Shi, T. Li, Y. Yuan: Damage characteristics and influence factors of mountain tunnels under strong earthquakes, *J Nat. Hazards*, 61 (2012), pp. 387-401.
- [18] EOTA EAD 332347-00-0601: Connector for strengthening of existing concrete structures by concrete overlay, Brussels: EOTA, March 2021.
- [19] EN 1998-1:2004: Eurocode 8: Design of structures for earthquake resistance - Part 1: General rules, seismic actions and rules for buildings, Brussels: CEN, 2004.
- [20] EN 1992-2: Eurocode 2: Design of concrete structures - Concrete bridges - Design and detailing rules, Brussels: CEN, 2005.
- [21] fib Model Code 2010, Bulletin 65, Lausanne, 2013.
- [22] EN 1992-1-2: 2004: Eurocode 2: Design of concrete structures – Part 1-2: General rules – Structural fire design, Brussels: CEN, 2004.
- [23] EOTA EAD 330499-01-0601: Bonded fasteners for use in concrete, Brussels: EOTA, December 2018.





Hilti Aktiengesellschaft  
9494 Schaan, Liechtenstein  
P +423-234 2965

[www.facebook.com/hiltigroup](https://www.facebook.com/hiltigroup)  
[www.hilti.group](https://www.hilti.group)